

Fittings Catalog



Bergstrom®



Air Conditioning & Heating
Replacement Parts

Fittings



Aeroquip E-Z Clip Fittings & Hoses	3
Accessories	3
Hoses	4
Lifesaver Braze Nipple Fitting	5
Female O-Ring Fittings	5
Bulkhead Fitting	5
Female O-Ring Pilot Fittings	6
Male O-Ring Fittings	8
Male Splicer Fittings	9
Female O-Ring Fittings	10
AIR-O-CRIMP Fittings	10
Male O-Ring Fittings	12
Splicer Fittings	14
Weld-On Fittings	16
AIR-O-CRIMP Assembly	17
ATCO Beadlock Fittings	18
Accessories	18
Goodyear (Galaxy) Hoses	18
Compression Fittings - Standard Barrier	20
Female Flare Fittings - Standard Barrier	20
Female O-Ring Fittings - Reduced Barrier	23
Male Insert O-Ring Fittings - Standard Barrier	24
Male O-Ring Fittings - Standard Barrier	25
Male O-Ring Fittings - Reduced Barrier	26
Splicer Fittings - Standard Barrier	27
Splicer Fittings - Reduced Barrier	27
Weld-On Fittings - Standard Barrier	27
Weld-On Fittings - Reduced Barrier	28
Beadlock Fitting Identification	30
Male O-Ring	31
Female O-Ring	31
Male Insert O-Ring	31
O-Rings	31
Female Flare	32
Male Flare	32
Hose End Sizes	32
Torque Recommendations	32

Refrigerant Hose Sizes	33
Beadlock	33
Torque Recommendations	33

Burgaflex Fittings	34
Goodyear (Galaxy) Hoses	34
Burgaflex Fittings - Standard Barrier	35
Burgaflex Fittings - Reduced Barrier	36
Burgaflex Crimp Fittings - Reduced Barrier	37
Burgaflex Accessories	38
Ferrule Fittings	38

O-Rings	39
O-Rings Specifications	40
O-Ring Assortment Kits	41
O-Ring Rubber Material Data	43

Bulkhead Adapters, Tubing & Drain Hoses	43
Bulkhead Adapters	43
Drain Hose & Accessories	44
Insulation Tubing	45
Tube & Fitting Assembly	45

Ducting, Clamps & Hoses	46
Flexible Ducting	46
Hose Clamps	46
Hoses	47

Accessories	47
Wire Clips & Ties	47



Aeroquip E-Z Clip Fittings & Hoses Accessories

FITTINGS

Cage to Hose Attachment
(quantity of 10)



Hose Size: No. 6	530380
Hose Size: No. 8	530381

Cage to Hose Attachment
(quantity of 10)



Hose Size: No. 10	530382
Hose Size: No. 12	530383

Hose Clip
(quantity of 10)



Hose Size: No. 6	530384
------------------	---------------

O-Ring Fittings (quantity of 5)



Hose Size: No. 6	1001562220
Hose Size: No. 8	1001562233

O-Ring Fittings (quantity of 5)



Hose Size: No. 10	1001562240
Hose Size: No. 12	1001562246
Hose Size: No. 16	1001562250

Hoses

Multi-Refrigerant Hose (must order in 50-foot increments)



Hose Size: No. 6	Hose Inner Diameter: 5/16" (7.9mm)	Hose Outer Diameter: 37/64" (14.7mm)	1002080211
Hose Size: No. 8	Hose Inner Diameter: 13/32" (10.3mm)	Hose Outer Diameter: 23/32" (17.8mm)	1002080684

Multi-Refrigerant Hose (must order in 50-foot increments)



Hose Size: No. 10	Hose Inner Diameter: 1/2" (12.7mm)	Hose Outer Diameter: 25/32" (19.8mm)	1002080687
Hose Size: No. 12	Hose Inner Diameter: 5/8" (15.9mm)	Hose Outer Diameter: 1" (24.9mm)	1002080699
Hose Size: No. 16	Hose Inner Diameter: 7/8" (22.4mm)	Hose Outer Diameter: 1 7/32" (31.2mm)	1001564223

Multi-Refrigerant Hose (must order in bulk)



Hose Size: No. 6	Hose Inner Diameter: 5/16" (7.9mm)	Hose Outer Diameter: 19/32" (14.7mm)	1002287239 (560-feet)
---------------------	--	--	---------------------------------

Multi-Refrigerant Hose (must order in bulk)



Hose Size: No. 8	Hose Inner Diameter: 13/32" (10.3mm)	Hose Outer Diameter: 23/32" (17.8mm)	1002287262 (575-feet)
Hose Size: No. 10	Hose Inner Diameter: 1/2" (12.7mm)	Hose Outer Diameter: 25/32" (19.8mm)	1002290824 (550-feet)
Hose Size: No. 12	Hose Inner Diameter: 5/8" (15.9mm)	Hose Outer Diameter: 1" (24.9mm)	1002292110 (367-feet)

All hoses have the following bend radius:

Hose Size: No. 6	Minimum Bend Radius: 2" (50mm)
Hose Size: No. 8	Minimum Bend Radius: 2 1/2" (63mm)
Hose Size: No. 10	Minimum Bend Radius: 3" (76.2mm)
Hose Size: No. 12	Minimum Bend Radius: 4" (101.6mm)
Hose Size: No. 16	Minimum Bend Radius: 7" (177.8mm)

FITTINGS



Aeroquip E-Z Clip Fittings & Hoses

Lifesaver Braze Nipple Fitting

Lifesave Braze Nipple Fitting



Hose Size: No. 8-No. 8	Length: 2 1/64" (51.3mm)	551168
Hose Size: No. 10-No. 10	Length: 2 1/32" (51.6mm)	551171
Hose Size: No. 12-No. 12	Length: 2 7/64" (53.6mm)	551172
Hose Size: No. 16-No. 16	Length: 2 13/64" (56.1mm)	1001562293

Bulkhead Fitting

Male 90 Degree Bulkhead Fitting



Fitting Size: No. 10-No. 10	Fitting Thread Size: 7/8"-14	551267
--------------------------------	---------------------------------	---------------

FITTINGS

Female O-Ring Fittings

Straight Female O-Ring Short Pilot



Fitting Size: No. 8-No. 8	Fitting Thread Size: 3/4"-16	Length: 3 9/16" (90.4mm)	550665
---------------------------------	---------------------------------------	--------------------------------	---------------

Straight Female O-Ring Short Pilot
(Step Up)



Fitting Size: No. 8-No. 10	Fitting Thread Size: 3/4"-16	Length: 3 9/16" (90.4mm)	550666
Fitting Size: No. 10-No. 12	Fitting Thread Size: 7/8"-14	Length: 3 21/32" (93mm)	550668

Straight Female O-Ring (Short Pilot)
with High Side Charge Port Fitting



Fitting Size: No. 8-No. 8	Fitting Thread Size: 3/4"-16	Length: 4 3/32" (103.9mm)	550672
------------------------------	---------------------------------------	---------------------------------	---------------

All Aeroquip E-Z Clip refrigerant fitting kits contain the fitting and all necessary cage, clips and o-rings.

Female O-Ring Fittings (cont'd)

Straight Female O-Ring (Short Pilot) with High Side Charge Port Fitting (Step Down)



Fitting Size: No. 8-No. 6	Fitting Thread Size: 3/4"-16	Length: 4 1/16" (103.1mm)	551272
------------------------------	---------------------------------	---------------------------------	---------------

Straight Female O-Ring (Long Pilot) with Switch Port Fitting



Fitting Size: No. 10-No. 10	Fitting Thread Size: 7/8"-14	Length: 4 15/64" (107.7mm)	550701
--------------------------------	---------------------------------	----------------------------------	---------------

Female 45 Degree Elbow O-Ring (Short Pilot) Fitting



Fitting Size: No. 8-No. 8	Fitting Thread Size: 3/4"-16	550678
------------------------------	---------------------------------	---------------

Female O-Ring Pilot Fittings

Female 45 Degree Elbow O-Ring (Short Pilot) Fitting (Step Up)



Fitting Size: No. 8-No. 10	Fitting Thread Size: 3/4"-16	550679
-------------------------------	---------------------------------	---------------

Female 90 Degree Elbow O-Ring (Short Pilot) Fitting (Step Up)



Fitting Size: No. 6-No. 8	Fitting Thread Size: 5/8"-18	550685
Fitting Size: No. 8-No. 10	Fitting Thread Size: 3/4"-16	550687
Fitting Size: No. 10-No. 12	Fitting Thread Size: 7/8"-14	550689

Female 90 Degree O-Ring (Short Pilot) with R-134a High Side Charge Port Fitting



Fitting Size: No. 6-No. 6	Fitting Thread Size: 5/8"-18	R134a Port: High Side Charge	550692
Fitting Size: No. 8-No. 8	Fitting Thread Size: 3/4"-16	R134a Port: High Side Charge	550693

FITTINGS



All Aeroquip E-Z Clip refrigerant fitting kits contain the fitting and all necessary cage, clips and o-rings.



Aeroquip E-Z Clip Fittings & Hoses

Female O-Ring Pilot Fittings (cont'd)

FITTINGS

Female 90 Degree O-Ring (Short Pilot) with R-134a High Side Charge Port Fitting (Step Up)



Fitting Size: No. 8-No. 10	Fitting Thread Size: 3/4"-16	R134a Port: 13mm	550694
----------------------------	------------------------------	------------------	---------------

Female 90 Degree Elbow O-Ring (Short Pilot) with R-134a Low Side Charge Port Fitting



Fitting Size: No. 10-No. 10	Fitting Thread Size: 7/8"-14	550695
-----------------------------	------------------------------	---------------

Female 90 Degree Elbow O-Ring (Short Pilot) with R-134a Low Side Charge Port Fitting (Step Up)



Fitting Size: No. 10-No. 12	Fitting Thread Size: 7/8"-14	550696
-----------------------------	------------------------------	---------------

Female 90 Degree O-Ring (Short Pilot) with R12 Port (7/16"-20 Thread) Fitting



Fitting Size: No. 10-No. 10	Fitting Thread Size: 7/8"-14	550703
-----------------------------	------------------------------	---------------

All Aeroquip E-Z Clip refrigerant fitting kits contain the fitting and all necessary cage, clips and o-rings.

Male O-Ring Fittings

Straight Male O-Ring (Short Pilot) Fitting



Fitting Size: No. 6-No. 6	Fitting Thread Size: 5/8"-18	Length: 3 13/32" (86.6mm)	550769
Fitting Size: No. 8-No. 8	Fitting Thread Size: 3/4"-18	Length: 4 3/8" (111mm)	550772
Fitting Size: No. 12-No. 12	Fitting Thread Size: 1 1/16"-16	Length: 3 11/16" (93.5mm)	550775

Straight Male O-Ring (Short Pilot) Fitting (Step Up)



Fitting Size: No. 6-No. 8	Fitting Thread Size: 5/8"-18	Length: 3 7/16" (87.1mm)	550771
Fitting Size: No. 10-No. 12	Fitting Thread Size: 7/8"-18	Length: 3 11/16" (93.4mm)	550774

Straight Male O-Ring (Short Pilot) with R-134a High Side Charge Port Fitting



Fitting Size: No. 10-No. 10	Fitting Thread Size: 7/8"-14	Length: 5" (127mm)	550787
-----------------------------	------------------------------	--------------------	---------------

Straight Male O-Ring (Short Pilot) with R-134a Low Side Charge Port Fitting (Step Up)



Fitting Size: No. 10-No. 12	Fitting Thread Size: 1 1/16"-16	Length: 5" (127mm)	550789
-----------------------------	---------------------------------	--------------------	---------------

Male O-Ring (Short Pilot) 45 Degree Elbow Fitting (Step Up)



Fitting Size: No. 6-No. 8	Fitting Thread Size: 5/8"-18	551183
---------------------------	------------------------------	---------------

Male O-Ring (Short Pilot) 90 Degree Elbow Fitting



Fitting Size: No. 6-No. 6	Fitting Thread Size: 5/8"-18	550776
Fitting Size: No. 8-No. 8	Fitting Thread Size: 3/4"-18	550778

FITTINGS



All Aeroquip E-Z Clip refrigerant fitting kits contain the fitting and all necessary cage, clips and o-rings.



800.499.6849 • shop.bergstrominc.com

Aeroquip E-Z Clip Fittings & Hoses

Male O-Ring Fittings (cont'd)

Male O-Ring (Short Pilot) 90 Degree Elbow with R-134a High Side Charge Port Fitting



Fitting Size: No. 10-No. 10	Fitting Thread Size: 7/8"-18	R134a Port: High Side Charge	550793
-----------------------------	------------------------------	------------------------------	---------------

Male O-Ring (Short Pilot) 90 Degree Elbow No. 6 Fitting (Step Up)



Fitting Size: No. 6-No. 8	Fitting Thread Size: 5/8"-18	550777
Fitting Size: No. 10-No. 12	Fitting Thread Size: 7/8"-14	550781

Male Insert O-Ring 180 Degree Fitting

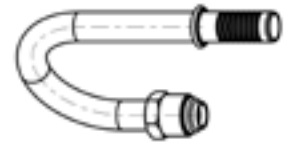

Fitting Size: No. 6-No. 8	Fitting Thread Size: 5/8"-18	1002111477
Fitting Size: No. 10-No. 12	Fitting Thread Size: 7/8"-14	1002111605

FITTINGS

Male Splicer Fittings

Straight Splicer Fitting



Fitting Size: No. 8-No. 8	Length: 4 49/64" (120.1mm)	550728
Fitting Size: No. 10-No. 10	Length: 5 11/16" (144.3mm)	550729
Fitting Size: No. 12-No. 12	Length: 4 23/32" (119.9mm)	550731

Splicer with High Side R134-a Charge Port Fitting



Fitting Size: No. 6-No. 6	Length: 5 13/32" (137.4mm)	550718
Fitting Size: No. 8-No. 8	Length: 5 39/64" (142.5mm)	550719
Fitting Size: No. 10-No. 10	Length: 5 5/8" (142.7mm)	550721
Fitting Size: No. 10-No. 10	Length: 5 5/8" (142.7mm)	550722
Fitting Size: No. 12-No. 12	Length: 5 43/64" (144mm)	550723

Splicer with Switch Port Fitting



Fitting Size: No. 6-No. 6	Length: 5 13/32" (137.4mm)	551178
Fitting Size: No. 8-No. 8	Length: 5 39/64" (142.2mm)	550724
Fitting Size: No. 12-No. 12	Length: 5 39/64" (142.2mm)	550726

All Aeroquip E-Z Clip refrigerant fitting kits contain the fitting and all necessary cage, clips and o-rings.

Male Splicer Fittings (cont'd)

Splicer T 3 Hose Connector Fitting



Fitting Size: No. 8-No. 8	Length: 5 31/64" (139.2mm)	550738
------------------------------	-------------------------------	---------------

Splicer 90 Degree Fitting



Fitting Size: No. 10-No. 10	550734
--------------------------------	---------------



Female O-Ring Fittings

Straight Female O-Ring Fitting with Clamp



Fitting Size: No. 6	Fitting Thread Size: 5/8"-18	Hose Size: No. 6	1000021465
Fitting Size: No. 8	Fitting Thread Size: 3/4"-16	Hose Size: No. 8	1000021519
Fitting Size: No. 10	Fitting Thread Size: 7/8"-14	Hose Size: No. 10	1000021544
Fitting Size: No. 12	Fitting Thread Size: 1 1/16"-14	Hose Size: No. 12	1000021564

Straight Female O-Ring Fitting with Clamp (Step Up)



Fitting Size: No. 6	Fitting Thread Size: 5/8"-18	Hose Size: No. 8	1000021571
Fitting Size: No. 10	Fitting Thread Size: 7/8"-14	Hose Size: No. 12	1000021587

Straight Female O-Ring with 13mm Switch or Service Port Fitting with Clamp



Fitting Size: No. 10	Fitting Thread Size: 7/8"-14	Hose Size: No. 10	1000021649
Fitting Size: No. 12	Fitting Thread Size: 1 1/16"-14	Hose Size: No. 12	1000021684

All Aeroquip E-Z Clip refrigerant fitting kits contain the fitting and all necessary cage, clips and o-rings.

AIR-O-CRIMP Fittings

Female O-Ring Fittings (cont'd)

FITTINGS

Straight Female O-Ring with 13mm Switch or Service Port Fitting with Clamp (Step Up)



Fitting Size: No. 10	Fitting Thread Size: 7/8"-14	Hose Size: No. 12	1000021705
----------------------	------------------------------	-------------------	-------------------

Straight Female O-Ring with 16mm Switch or Service Port Fitting with Clamp



Fitting Size: No. 8	Fitting Thread Size: 3/4"-16	Hose Size: No. 8	1000021905
---------------------	------------------------------	------------------	-------------------

Straight Metric Female O-Ring M20 Fitting with Clamp



Fitting Size: M20	Fitting Thread Size: M20 x 1.5	Hose Size: No. 8	1000021964
-------------------	--------------------------------	------------------	-------------------

Female 45 Degree O-Ring Fitting with Clamp



Fitting Size: No. 6	Fitting Thread Size: 5/8"-18	Hose Size: No. 6	1000022604
Fitting Size: No. 8	Fitting Thread Size: 3/4"-16	Hose Size: No. 8	1000022607
Fitting Size: No. 12	Fitting Thread Size: 1 1/16"-14	Hose Size: No. 12	1000022623

Female 90 Degree O-Ring Fitting with Clamp



Fitting Size: No. 6	Fitting Thread Size: 5/8"-18	Hose Size: No. 6	1000021997
Fitting Size: No. 8	Fitting Thread Size: 3/4"-16	Hose Size: No. 8	1000022005
Fitting Size: No. 10	Fitting Thread Size: 7/8"-14	Hose Size: No. 10	1000022068
Fitting Size: No. 12	Fitting Thread Size: 1 1/16"-14	Hose Size: No. 12	1000022073

Female 90 Degree O-Ring Fitting with Clamp (Step Up)



Fitting Size: No. 6	Fitting Thread Size: 5/8"-18	Hose Size: No. 8	1000022089
Fitting Size: No. 8	Fitting Thread Size: 3/4"-16	Hose Size: No. 10	1000022105

Female O-Ring Fittings (cont'd)

Female 90 Degree O-Ring with 16mm Switch or Service Port Fitting with Clamp



Fitting Size: No. 8	Fitting Thread Size: 3/4"-16	Hose Size: No. 8	1000022164
---------------------	------------------------------	------------------	-------------------

Female 90 Degree O-Ring with 13mm Switch or Service Port Fitting with Clamp



Fitting Size: No. 10	Fitting Thread Size: 7/8"-14	Hose Size: No. 10	1000022514
----------------------	------------------------------	-------------------	-------------------

Female 90 Degree O-Ring with 13mm Switch or Service Port Fitting with Clamp (Step Up)



Fitting Size: No. 10	Fitting Thread Size: 7/8"-14	Hose Size: No. 12	1000022519
----------------------	------------------------------	-------------------	-------------------

FITTINGS



Male O-Ring Fittings

Straight Male Insert O-Ring Fitting with Clamp



Fitting Size: No. 6	Fitting Thread Size: 5/8"-18	Hose Size: No. 6	1000022945
---------------------	------------------------------	------------------	-------------------

Fitting Size: No. 8	Fitting Thread Size: 3/4"-16	Hose Size: No. 8	1000022947
---------------------	------------------------------	------------------	-------------------

Straight Male O-Ring Fitting with Clamp



Fitting Size: No. 6	Fitting Thread Size: 5/8"-18	Hose Size: No. 6	1000022648
---------------------	------------------------------	------------------	-------------------

Fitting Size: No. 8	Fitting Thread Size: 3/4"-16	Hose Size: No. 8	1000022746
---------------------	------------------------------	------------------	-------------------

Straight Male O-Ring Fitting with Clamp (Step Up)



Fitting Size: No. 6	Fitting Thread Size: 5/8"-18	Hose Size: No. 8	1000022704
---------------------	------------------------------	------------------	-------------------

Fitting Size: No. 10	Fitting Thread Size: 7/8"-14	Hose Size: No. 12	1000022764
----------------------	------------------------------	-------------------	-------------------

AIR-O-CRIMP Fittings

Male O-Ring Fittings (cont'd)

FITTINGS

Straight O-Ring Fitting with Clamp and Neoprene O-Ring



Fitting Size: No. 12	Hose Size: No. 12	1001844355
----------------------	-------------------	-------------------

Straight O-Ring Fitting with Clamp and Neoprene O-Ring (Step Up)



Fitting Size: No. 6	Hose Size: No. 8	1001842799
---------------------	------------------	-------------------

Male 45 Degree O-Ring Fitting with Clamp



Fitting Size: No. 10	Fitting Thread Size: 7/8"-18	Hose Size: No. 10	1000022873
----------------------	------------------------------	-------------------	-------------------

Male 90 Degree O-Ring Fitting with Clamp



Fitting Size: No. 6	Fitting Thread Size: 5/8"-18	Hose Size: No. 6	1000022805
Fitting Size: No. 8	Fitting Thread Size: 3/4"-18	Hose Size: No. 8	1000022809
Fitting Size: No. 10	Fitting Thread Size: 7/8"-18	Hose Size: No. 10	1000022813
Fitting Size: No. 12	Fitting Thread Size: 1 1/16"-16	Hose Size: No. 12	1000022824

Male 90 Degree O-Ring Fitting with Clamp (Step Up)



Fitting Size: No. 6	Fitting Thread Size: 5/8"-18	Hose Size: No. 8	1000022807
Fitting Size: No. 10	Fitting Thread Size: 7/8"-18	Hose Size: No. 12	1000022815

Male 90 Degree O-Ring Fitting with Clamp and Neoprene O-Ring



Fitting Size: No. 12	Hose Size: No. 12	1001851271
----------------------	-------------------	-------------------

Male O-Ring Fittings (cont'd)

Male 90 Degree O-Ring Fitting with Clamp and Neoprene O-Ring (Step Up)



Fitting Size: No. 6	Hose Size: No. 8	1001851262
---------------------	------------------	-------------------

FITTINGS



Splicer Fittings

Straight Splicer with Clamp Assembly Fitting



Fitting Size: No. 8	Hose Size: No. 8	1000023624
Fitting Size: No. 10	Hose Size: No. 10	1000023644
Fitting Size: No. 12	Hose Size: No. 12	1000023646

Straight Splicer with 7/16-20 Valve Core Port with Clamp Assembly Fitting



Fitting Size: No. 8	Hose Size: No. 8	1001326527
---------------------	------------------	-------------------

Straight Splicer with M10 Switch or Service Port with Clamp Assembly Fitting



Fitting Size: No. 10-No. 10-No. 10	Hose Size: No. 10	Thread Size: M10-1.25	1000023934
------------------------------------	-------------------	-----------------------	-------------------

AIR-O-CRIMP Fittings

Splicer Fittings (cont'd)

Straight Splicer with 13mm Switch or Service Port with Clamp Assembly Fitting



Fitting Size: No. 10-No. 10	Hose Size: No. 10	Thread Size: 13mm	1000023967
-----------------------------	-------------------	-------------------	-------------------

Straight Splicer with 16mm Switch or Service Port with Clamp Assembly Fitting



Fitting Size: No. 8-No. 8	Hose Size: No. 8	Thread Size: 16mm	1000023951
---------------------------	------------------	-------------------	-------------------

T-Splicer 3-Way Barb with Clamp Assembly Fitting



Fitting Size: No. 8	Hose Inner Diameter: No. 8	1000024025
---------------------	----------------------------	-------------------

FITTINGS

Y-Splicer 3-Way Barb with Clamp Fitting



Fitting Size: No. 8	Hose Inner Diameter: No. 8	1000024174
Fitting Size: No. 12	Hose Inner Diameter: No. 12	1000024184

Weld-On Fittings

**Straight Weld-On Barb Kit with
Clamp Fitting**



Fitting Size: No. 6	Hose Size: No. 6	1000024213
Fitting Size: No. 8	Hose Size: No. 8	1000025085
Fitting Size: No. 10	Hose Size: No. 10	1000025095
Fitting Size: No. 12	Hose Size: No. 12	1000025138

FITTINGS



AIR-O-CRIMP Fittings

AIR-O-CRIMP Assembly

Cut or trim the hose.

Cut or trim the hose to the desired length using the kwikcut hose cutter. The cut should be made square to the hose length.



Assemble the clamp.

Assemble the clamp assembly onto the hose with the locator tab positioned approximately where the fitting groove will be when the fitting is assembled.



Apply refrigerant oil.

Apply a small amount of refrigerant oil (PAG or Ester) to the fitting barb and o-rings (optional). Assemble the fitting into the hose until the hose touches the ramped step on the fitting. Adjust the clamp assembly so the tab on the locator "snaps" into the groove of the fitting.



Crimp clamps.

Using the air crimp gun or the manual crimp pliers, crimp each clamp separately.

Caution: If using the manual pliers, make sure that there is a metal to metal contact of the clamp ear when the crimp is made. There will be a slight amount of spring-back of the clamp ear when the crimp pliers are released. Failure to fully close the clamp may result in refrigerant leaks.



Locator comes off.

The locator will "pop off" after the second clamp is crimped and can be discarded. The result is a clean appearance and a reliable assembly.



Accessories

ATCO Hose Clamp Assembly
(packaged in quantities of 10)



Hose Size: No. 6	Color: Red	1000025384
Hose Size: No. 8	Color: Black	1000025389
Hose Size: No. 10	Color: Yellow	1000025392
Hose Size: No. 12	Color:	1000197772
Hose Size: No. 16	Color:	1000197779



Goodyear (Galaxy) Hoses

- **This hose meets J2064 specification**
- **Easy Couplability**
Internal rubber layer makes coupling simple, assuring better assembly integrity while reducing the risk of refrigerant loss around the fittings.
- **Reduced Ozone Permeation**
Internal Nylon Barrier hose is specifically designed to reduce the permeation level of ozone depleting refrigerant and chemicals in heavy duty air conditioning systems.
- **Universal Compatibility**
Extensive testing has shown 4826 Barrier Hose to be compatible with R-12, R-134a and Ternary Blends.
- Low Volumetric Expansion
- Dimensionally Stable
- Flexible
- Easy to Route
- Reduction in Noise & Vibration
- J51 All Outside Diameters
- Tube: Polychloropene Barrier
- Reinforcement: Synthetic Yarn
- Cover: EPDM

NOTE: For use with steel or aluminum Push-On or Beadlock (Bubble Crimp) type fittings only!

ATCO Beadlock Fittings

Goodyear (Galaxy) Hoses (cont'd)

Goodyear (Galaxy) 4826 Hose for Standard Fitting



Length: 50 Ft.	Hose Inner Diameter: 5/16" (7.9mm)	Hose Outer Diameter: 3/4" (19.1mm)	550307
Length: 50 Ft.	Hose Inner Diameter: 13/32" (10.3mm)	Hose Outer Diameter: 29/32" (23mm)	550308
Length: 50 Ft.	Hose Inner Diameter: 1/2" (12.7mm)	Hose Outer Diameter: 1" (25.4mm)	550309
Length: 50 Ft.	Hose Inner Diameter: 5/8" (15.9mm)	Hose Outer Diameter: 1 1/8" (28.6mm)	550310
Length: 825 Ft.	Hose Inner Diameter: 5/16" (7.9mm)	Hose Outer Diameter: 3/4" (19.1mm)	1002300977
Length: 725 Ft.	Hose Inner Diameter: 13/32" (10.3mm)	Hose Outer Diameter: 29/32" (23mm)	1002301587
Length: 700 Ft.	Hose Inner Diameter: 1/2" (12.7mm)	Hose Outer Diameter: 1" (25.4mm)	1002301589

Goodyear (Galaxy) 4890 Hose for Reduced Fitting



Length: 50 Ft.	Hose Inner Diameter: 5/16" (7.9mm)	Hose Outer Diameter: 9/16" (14.7mm)	1001639549
Length: 50 Ft.	Hose Inner Diameter: 13/32" (10.3mm)	Hose Outer Diameter: 11/16" (17.3mm)	1001639551
Length: 50 Ft.	Hose Inner Diameter: 1/2" (12.7mm)	Hose Outer Diameter: 3/4" (19.4mm)	1001639552
Length: 50 Ft.	Hose Inner Diameter: 5/8" (15.9mm)	Hose Outer Diameter: 15/16" (23.6mm)	1001639553
Length: 825 Ft.	Hose Inner Diameter: 5/16" (7.9mm)	Hose Outer Diameter: 9/16" (14.7mm)	1001260067
Length: 725 Ft.	Hose Inner Diameter: 13/32" (10.3mm)	Hose Outer Diameter: 11/16" (17.3mm)	1001260070
Length: 600 Ft.	Hose Inner Diameter: 1/2" (12.7mm)	Hose Outer Diameter: 3/4" (19.4mm)	1002300971
Length: 600 Ft.	Hose Inner Diameter: 1/2" (12.7mm)	Hose Outer Diameter: 3/4" (19.4mm)	1001260075
Length: 425 Ft.	Hose Inner Diameter: 5/8" (15.9mm)	Hose Outer Diameter: 15/16" (23.6mm)	1002300976
Length: 425 Ft.	Hose Inner Diameter: 5/8" (15.9mm)	Hose Outer Diameter: 15/16" (23.6mm)	1001260076

Compression Fittings - Standard Barrier

Straight Compression Fitting
(Standard Barrier)



Fitting Size: No. 10	Fitting Thread Size: 5/8" Tube	Hose Size: No. 10	550979
Fitting Size: No. 12	Fitting Thread Size: 3/4" Tube	Hose Size: No. 12	550980

FITTINGS



Female Flare Fittings - Standard Barrier

Straight Female Flare Fitting
(Standard Barrier)



Fitting Size: No. 6	Fitting Thread Size: 5/8"-18	Hose Size: No. 6	550992
Fitting Size: No. 8	Fitting Thread Size: 3/4"-16	Hose Size: No. 8	550993

Straight Female O-Ring Fitting
(Standard Barrier)



Fitting Size: No. 6	Fitting Thread Size: 5/8"-18	Hose Size: No. 6	B409022
Fitting Size: No. 8	Fitting Thread Size: 3/4"-16	Hose Size: No. 8	B409023
Fitting Size: No. 12	Fitting Thread Size: 1 1/16"-14	Hose Size: No. 12	B409025

Straight Female O-Ring Fitting
(Standard Barrier, Step Up)



Fitting Size: No. 8	Fitting Thread Size: 3/4"-16	Hose Size: No. 10	B409027
Fitting Size: No. 10	Fitting Thread Size: 7/8"-14	Hose Size: No. 12	B409028

ATCO Beadlock Fittings

Female O-Ring Fittings - Standard Barrier (cont'd)

FITTINGS

**Straight Female O-Ring Fitting
(Standard Barrier, Step Down)**



Fitting Size: No. 8	Fitting Thread Size: 3/4"-16	Hose Size: No. 6	B409077
---------------------	------------------------------	------------------	----------------

Straight Female O-Ring with R-134a Port Metric Thread Fitting (Standard Barrier)



Fitting Size: No. 8	Fitting Thread Size: M10 x 1.25	Hose Size: 3/4"-16	B409087
---------------------	---------------------------------	--------------------	----------------

Straight Female O-Ring (Short Pilot) with 16mm High Side Charge Port Fitting (Standard Barrier)



Fitting Size: No. 6	Fitting Thread Size: 5/8"-18	Hose Size: No. 6	550671
---------------------	------------------------------	------------------	---------------

**Female 45 Degree O-Ring Fitting
(Standard Barrier)**



Fitting Size: No. 8	Fitting Thread Size: 3/4"-16	Hose Size: No. 8	B409009
---------------------	------------------------------	------------------	----------------

**Female 45 Degree O-Ring Fitting
(Standard Barrier, Step Up)**



Fitting Size: No. 6	Fitting Thread Size: 5/8"-18	Hose Size: No. 8	B409100
---------------------	------------------------------	------------------	----------------

**Female 90 Degree O-Ring Fitting
(Standard Barrier)**



Fitting Size: No. 6	Fitting Thread Size: 5/8"-18	Hose Size: No. 6	B409000
Fitting Size: No. 8	Fitting Thread Size: 3/4"-16	Hose Size: No. 8	B409001
Fitting Size: No. 12	Fitting Thread Size: 1 1/16"-14	Hose Size: No. 12	B409003

Female O-Ring Fittings - Standard Barrier (cont'd)

Female 90 Degree O-Ring Fitting (Standard Barrier, Step Down)



Fitting Size: No. 8	Fitting Thread Size: 3/4"-16	Hose Size: No. 6	B409076
---------------------	------------------------------	------------------	----------------

90 Degree Female 16mm R-134a Port and M10 Switch (Offset) O-Ring Fitting (Standard Barrier)



Fitting Size: No. 8	Fitting Thread Size: 3/4"-16	Hose Size: No. 8	B409046
---------------------	------------------------------	------------------	----------------

Female 90 Degree O-Ring with 13mm R-134a Port Fitting (Standard Barrier)



Fitting Size: No. 10	Fitting Thread Size: 7/8"-14	Hose Size: No. 10	B409017
----------------------	------------------------------	-------------------	----------------

Female 90 Degree O-Ring with 16mm R-134a Port Fitting (Standard Barrier)



Fitting Size: No. 8	Fitting Thread Size: 3/4"-16	Hose Size: No. 8	B409016
---------------------	------------------------------	------------------	----------------

Female 90 Degree O-Ring with M10 R-134a Port Fitting (Standard Barrier)



Fitting Size: No. 12	Fitting Thread Size: 1 1/16"-14	Hose Size: No. 10	B409039
----------------------	---------------------------------	-------------------	----------------

90 Degree Female 16mm R-134a Port and M10 Switch (Offset) O-Ring Fitting (Standard Barrier)



Fitting Size: No. 8	Fitting Thread Size: 3/4"-16	Hose Size: No. 8	B409045
---------------------	------------------------------	------------------	----------------

FITTINGS



ATCO Beadlock Fittings

Female O-Ring Fittings - Reduced Barrier

FITTINGS

Straight Female O-Ring Fitting (Reduced Barrier)



Fitting Size: No. 6	Fitting Thread Size: 5/8"-18	Hose Size: No. 6	1001580089
Fitting Size: No. 10	Fitting Thread Size: 7/8"-14	Hose Size: No. 10	1001580093
Fitting Size: No. 12	Fitting Thread Size: 1 1/16"-14	Hose Size: No. 12	1001580096

Straight Female O-Ring Fitting (Reduced Barrier, Step Down)



Fitting Size: No. 10	Fitting Thread Size: 7/8"-14	Hose Size: No. 8	1001580103
----------------------	------------------------------	------------------	-------------------

Straight Female O-Ring Metric Thread Fitting (Reduced Barrier)



Fitting Size: M20	Fitting Thread Size: M20 x 1.5	Hose Size: No. 8	1001580201
-------------------	--------------------------------	------------------	-------------------

Female 45 Degree O-Ring Fitting (Reduced Barrier)



Fitting Size: No. 6	Fitting Thread Size: 5/8"-18	Hose Size: No. 6	1001580106
Fitting Size: No. 8	Fitting Thread Size: 3/4"-16	Hose Size: No. 8	1001580108
Fitting Size: No. 10	Fitting Thread Size: 7/8"-14	Hose Size: No. 10	1001580109
Fitting Size: No. 12	Fitting Thread Size: 1 1/16"-14	Hose Size: No. 12	1001580111

Female 90 Degree O-Ring Fitting (Reduced Barrier)



Fitting Size: No. 8	Fitting Thread Size: 3/4"-16	Hose Size: No. 8	552-C053
---------------------	------------------------------	------------------	-----------------

Female 90 Degree O-Ring Fitting (Reduced Barrier)



Fitting Size: No. 10	Fitting Thread Size: 7/8"-14	Hose Size: No. 10	1001580119
Fitting Size: No. 12	Fitting Thread Size: 1 1/16"-14	Hose Size: No. 12	1001580123

Female O-Ring Fittings - Reduced Barrier (cont'd)

Female 90 Degree O-Ring with 13mm R-134a Port Fitting (Reduced Barrier)



Fitting Size: No. 10	Fitting Thread Size: 7/8"-14	Hose Size: No. 10	1001580120
----------------------	------------------------------	-------------------	-------------------

Female 90 Degree O-Ring with 16mm R-134a Port Fitting (Reduced Barrier)



Fitting Size: No. 6	Fitting Thread Size: 5/8"-18	Hose Size: No. 6	1001580117
Fitting Size: No. 8	Fitting Thread Size: 3/4"-16	Hose Size: No. 8	1000349946

FITTINGS



Male Insert O-Ring Fittings - Standard Barrier

Straight Male Insert O-Ring Fitting (Standard Barrier)



Fitting Size: No. 6	Fitting Thread Size: 5/8"-18	Hose Size: No. 6	B409086
Fitting Size: No. 10	Fitting Thread Size: 7/8"-14	Hose Size: No. 10	B409097

Straight Male Insert O-Ring Fitting (Standard Barrier)



Fitting Size: No. 10	Fitting Thread Size: 7/8"-14	Hose Size: No. 10	1001579692
----------------------	------------------------------	-------------------	-------------------

ATCO Beadlock Fittings

Male O-Ring Fittings - Standard Barrier

FITTINGS

Straight Male O-Ring Special Dryer Connection Fitting (Standard Barrier)



Fitting Size: No. 7	Fitting Thread Size: 11/16"-16	Hose Size: No. 6	550966
---------------------	--------------------------------	------------------	---------------

Straight Male O-Ring Fitting (Standard Barrier)



Fitting Size: No. 6	Fitting Thread Size: 5/8"-18	Hose Size: No. 6	B409013
Fitting Size: No. 10	Fitting Thread Size: 7/8"-18	Hose Size: No. 10	B409014

Straight Male O-Ring Fitting (Standard Barrier, Step Up)



Fitting Size: No. 6	Fitting Thread Size: 5/8"-18	Hose Size: No. 8	B409091
Fitting Size: No. 10	Fitting Thread Size: 7/8"-18	Hose Size: No. 12	B409015

Straight Male O-Ring M10 Switch Port and 16mm R-134a Port Fitting (Standard Barrier)



Fitting Size: No. 10	Fitting Thread Size: 7/8"-18	Hose Size: No. 10	B409047
----------------------	------------------------------	-------------------	----------------

Male 90 Degree O-Ring Special Dryer Connection Fitting (Standard Barrier)



Fitting Size: No. 7	Fitting Thread Size: 11/16"-16	Hose Size: No. 6	550938
---------------------	--------------------------------	------------------	---------------

Male 90 Degree O-Ring Fitting (Standard Barrier)



Fitting Size: No. 8	Fitting Thread Size: 3/4"-16	Hose Size: No. 8	B409094
Fitting Size: No. 10	Fitting Thread Size: 7/8"-18	Hose Size: No. 10	B409041

Male O-Ring Fittings - Standard Barrier (cont'd)

Male 90 Degree O-Ring 16mm Port Fitting (Standard Barrier)



Fitting Size: No. 6	Fitting Thread Size: 5/16"	Hose Size: No. 6	551153
---------------------	----------------------------	------------------	---------------

Male 90 Degree O-Ring 13mm Port Fitting, Standard Barrier



Fitting Size: No. 10	Fitting Thread Size: 7/8"-18	Hose Size: No. 12	1001594399
----------------------	------------------------------	-------------------	-------------------

90 Degree O-Ring M10 Port Fitting (Standard Barrier, Step Up)



Fitting Size: No. 6	Fitting Thread Size: 7/8"-18	Hose Size: No. 8	B409037
---------------------	------------------------------	------------------	----------------

FITTINGS



Male O-Ring Fittings - Reduced Barrier

Straight Male O-Ring Fitting (Reduced Barrier)



Fitting Size: No. 10	Fitting Thread Size: 7/8"-14	Hose Size: No. 10	1001580133
----------------------	------------------------------	-------------------	-------------------

Male 45 Degree O-Ring Fitting (Reduced Barrier)



Fitting Size: No. 10	Fitting Thread Size: 7/8"-14	Hose Size: No. 10	1001580140
----------------------	------------------------------	-------------------	-------------------

Male 45 Degree O-Ring Fitting (Reduced Barrier, Step Up)



Fitting Size: No. 10	Fitting Thread Size: 7/8"-14	Hose Size: No. 12	1001580143
----------------------	------------------------------	-------------------	-------------------

ATCO Beadlock Fittings

Splicer Fittings - Standard Barrier

Straight Splicer Fitting (Standard Barrier)



Hose Size: No. 6	Hose Size: No. 6	550414
Hose Size: No. 8	Hose Size: No. 8	B409055
Hose Size: No. 10	Hose Size: No. 10	B409056
Hose Size: No. 12	Hose Size: No. 12	B409057

Straight Splicer with 1/4" Service Port Fitting (Standard Barrier)



Hose Size: No. 10	Hose Size: No. 10	1001580069
Hose Size: No. 12	Hose Size: No. 12	1001580070

90 Degree Splicer Fitting (Standard Barrier)



Hose Size: No. 6	Hose Size: No. 6	1001580073
------------------	------------------	-------------------

FITTINGS

Splicer Fittings - Reduced Barrier

Straight Splicer with 13mm R-134a Port Fitting (Reduced Barrier)



Fitting Size: No. 12	Hose Size: No. 12	1001580182
----------------------	-------------------	-------------------

Weld-On Fittings - Standard Barrier

Straight Weld-On Fitting (Standard Barrier)



Fitting Size: No. 6	Fitting Thread Size: 3/8" Tube	Hose Size: No. 6	1001338290
Fitting Size: No. 8	Fitting Thread Size: 1/2" Tube	Hose Size: No. 8	1001338301
Fitting Size: No. 10	Fitting Thread Size: 5/8" Tube	Hose Size: No. 10	1001338564
Fitting Size: No. 12	Fitting Thread Size: 3/4" Tube	Hose Size: No. 12	1001338581

Weld-On Fittings - Reduced Barrier

Straight Weld-On Fitting (Reduced Barrier)



Fitting Size: No. 8	Fitting Thread Size: 1/2" Tube	Hose Size: No. 8	1001580190
---------------------	--------------------------------	------------------	-------------------

Straight Weld-On Fitting (Reduced Barrier, Step Up)



Fitting Size: No. 10	Fitting Thread Size: 5/8" Tube	Hose Size: No. 12	1001580200
----------------------	--------------------------------	-------------------	-------------------



CORRECT BUBBLE CRIMP

CORRECT BUBBLE CRIMP

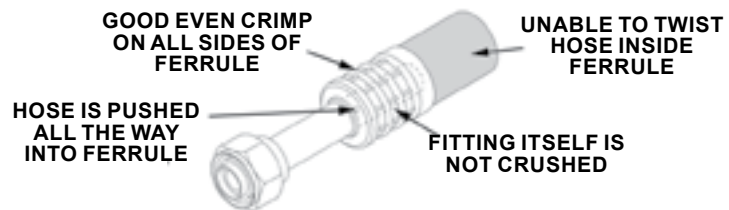

INCORRECT BUBBLE CRIMP

OVER CRIMPING

Can damage inner lining and/or fitting due to over torque or wrong size crimping die selection.

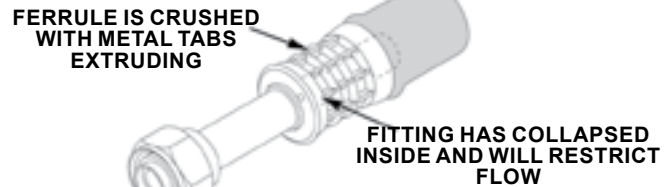

INCORRECT BUBBLE CRIMP

UNDER CRIMPING

Can cause hose to blow off fitting due to wrong die size selection or under crimping. Typically hose will rotate easily if fitting is under crimped.

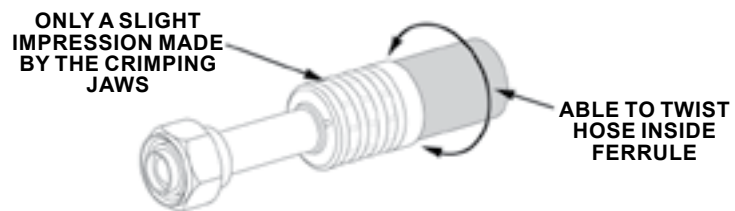

INCORRECT BUBBLE CRIMP

UNEVEN CRIMPING

Caused when hose is not pushed all the way into ferrule. Can cause hose to blow off due to insufficient number of crimps on ferrule/

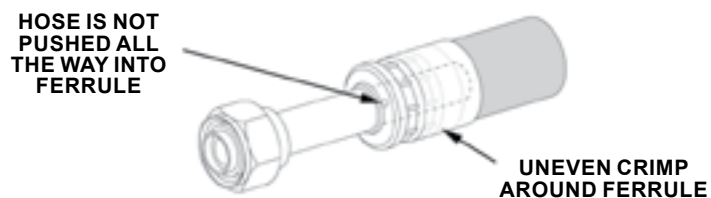

CRIMPING PROCEDURES FOR TYPICAL MOBILE REFRIGERATION HOSE:

STEP 1 Determine hose size needed. (See “Beadlock Fitting Identification”, “Goodyear (Galaxy) Hoses” on page 18.)

STEP 2 Determine hose fitting size and type needed.



STEP 3 Make certain that the end of hose to be crimped is cut evenly.



STEP 4 Push hose ALL the way into ferrule until hose is flush with peephole at the end of the ferrule.

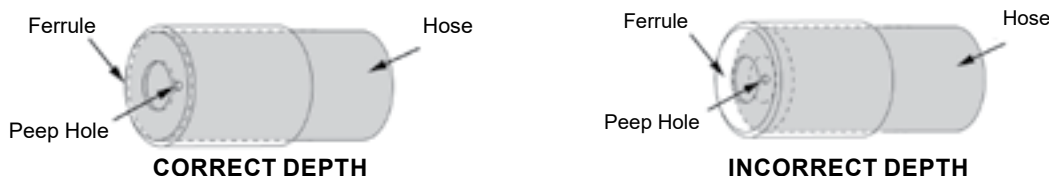

NOTE: It may be necessary to lubricate the hose inside diameter and/or hose fitting barbs

STEP 5 Determine correct crimping die size to match hose and fitting size. There are basically two types of crimp styles (see below).

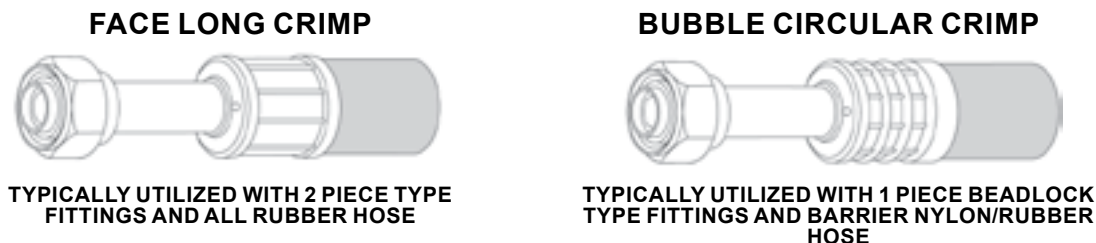

STEP 6 Crimp hose/fitting based on specific crimping machine manufacturer’s recommendations. Reference the following illustrations for some common examples of correct and incorrect crimping.



Beadlock Fitting Identification

Male O-Ring

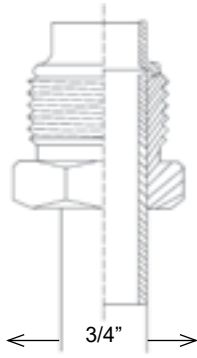

No. 12
1 1/16"-16 Thread



No. 10
7/8"-18 Thread



No. 8
3/4"-18 Thread



No. 6
5/8"-18 Thread

SPECIAL GM
DRIER FITTING

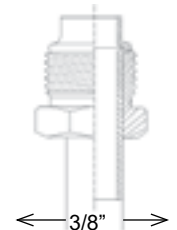

No. 6
11/16"-16 Thread

FITTINGS

Female O-Ring

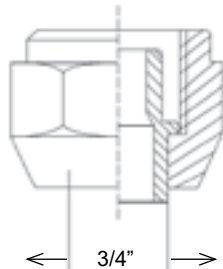

No. 12
1 1/16"-14 Thread

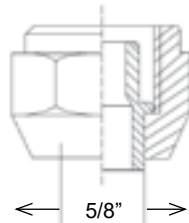

No. 10
7/8"-14 Thread

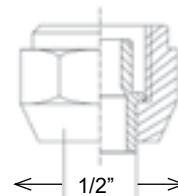

No. 8
3/4"-16 Thread

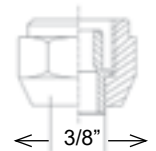

No. 6
5/8"-18 Thread

Male Insert O-Ring

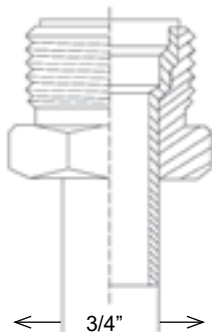

No. 12
1 1/16"-14 Thread

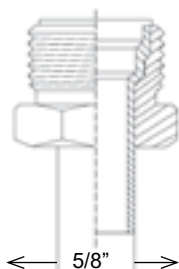

No. 10
7/8"-14 Thread

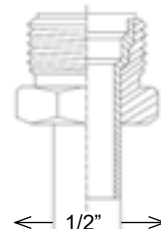

No. 8
3/4"-16 Thread



No. 6
5/8"-18 Thread

O-Rings



No. 12



No. 10



No. 8



No. 6



Female Flare

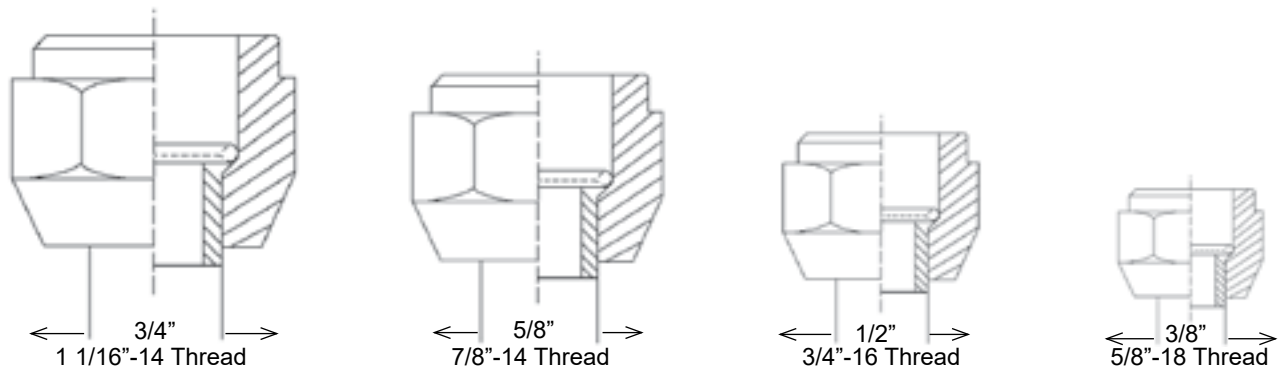

Male Flare

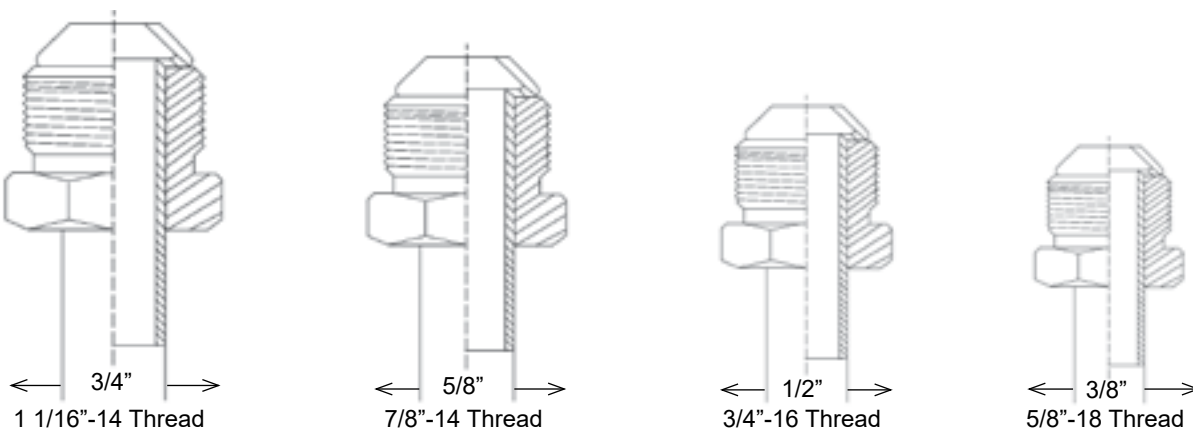

Hose End Sizes

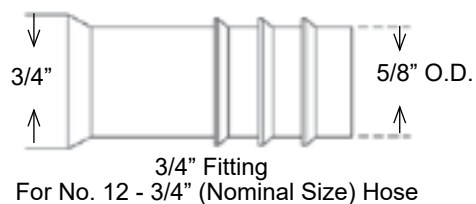
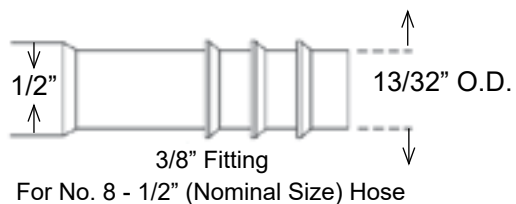
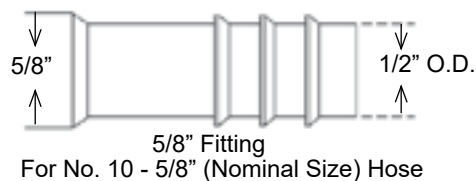
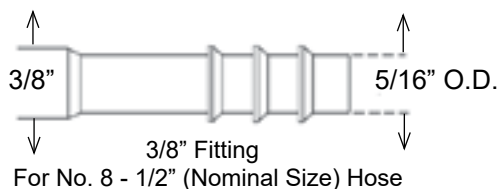

Torque Recommendations

FLARE CONNECTIONS		
Tube O.D.	Thread Size	Ft./Lb.
3/8"	5/8"	18-20
1/2"	3/4"	36-39
5/8"	7/8"	52-57
3/4"	1 1/16"	71-79

Beadlock Fitting Identification

Refrigerant Hose Sizes

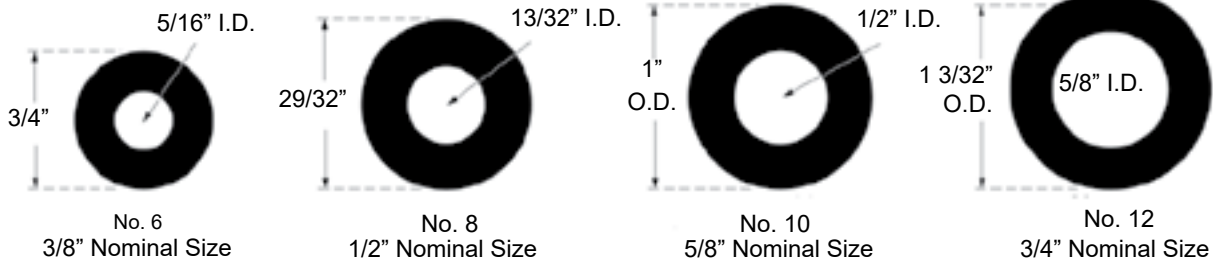

Beadlock

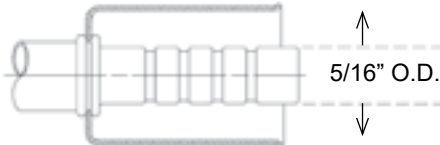

3/8" FITTING FOR NO. 6 HOSE

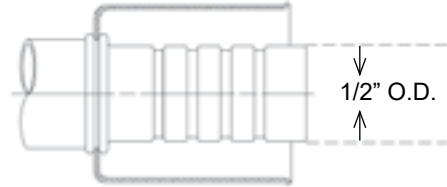

5/8" FITTING FOR NO. 10 HOSE

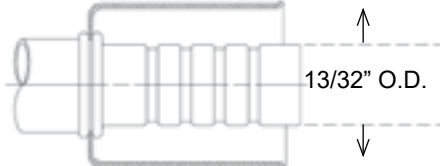

1/2" FITTING FOR NO. 8 HOSE

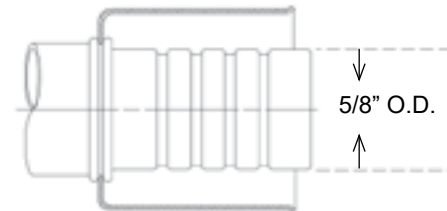

3/4" FITTING FOR NO. 12 HOSE

Torque Recommendations

FLARE CONNECTIONS		
Tube O.D.	Thread Size	Ft./Lb.
3/8"	5/8"	18-20
1/2"	3/4"	36-39
5/8"	7/8"	52-57
3/4"	1 1/16"	71-79

O-RING CONNECTIONS		
Tube O.D.	Thread Size	Ft./Lb.
3/8"	5/8"	11-13
1/2"	3/4"	15-20
5/8"	7/8"	21-27
3/4"	1 1/16"	28-33



Goodyear (Galaxy) Hoses

- **This hose meets J2064 specification**
- **Easy Couplability**
Internal rubber layer makes coupling simple, assuring better assembly integrity while reducing the risk of refrigerant loss around the fittings.
- **Reduced Ozone Permeation**
Internal Nylon Barrier hose is specifically designed to reduce the permeation level of ozone depleting refrigerant and chemicals in heavy duty air conditioning systems.
- **Universal Compatibility**
Extensive testing has shown 4826 Barrier Hose to be compatible with R-12, R-134a and Ternary Blends.
- **Low Volumetric Expansion**
- Dimensionally Stable
- Flexible
- Easy to Route
- Reduction in Noise & Vibration
- J51 All Outside Diameters
- Tube: Polychloropene Barrier
- Reinforcement: Synthetic Yarn
- Cover: EPDM

NOTE: For use with steel or aluminum Push-On or Beadlock (Bubble Crimp) type fittings only!



Goodyear (Galaxy) 4826 Hose for Standard Fitting			
Length: 50 Ft.	Hose Inner Diameter: 5/16" (7.9mm)	Hose Outer Diameter: 3/4" (19.1mm)	550307
Hose Size: No. 6			
Length: 50 Ft.	Hose Inner Diameter: 13/32" (10.3mm)	Hose Outer Diameter: 29/32" (23mm)	550308
Hose Size: No. 8			
Length: 50 Ft.	Hose Inner Diameter: 1/2" (12.7mm)	Hose Outer Diameter: 1" (25.4mm)	550309
Hose Size: No. 10			
Length: 50 Ft.	Hose Inner Diameter: 5/8" (15.9mm)	Hose Outer Diameter: 1 1/8" (28.6mm)	550310
Hose Size: No. 12			
Length: 825 Ft.	Hose Inner Diameter: 5/16" (7.9mm)	Hose Outer Diameter: 3/4" (19.1mm)	1002300977
Hose Size: No. 6			
Length: 725 Ft.	Hose Inner Diameter: 13/32" (10.3mm)	Hose Outer Diameter: 29/32" (23mm)	1002301587
Hose Size: No. 8			
Length: 700 Ft.	Hose Inner Diameter: 1/2" (12.7mm)	Hose Outer Diameter: 1" (25.4mm)	1002301589
Hose Size: No. 10			



Goodyear (Galaxy) 4890 Hose for Reduced Fitting			
Length: 50 Ft.	Hose Inner Diameter: 5/16" (7.9mm)	Hose Outer Diameter: 9/16" (14.7mm)	1001639549
Hose Size: No. 6			
Length: 50 Ft.	Hose Inner Diameter: 13/32" (10.3mm)	Hose Outer Diameter: 11/16" (17.3mm)	1001639551
Hose Size: No. 8			
Length: 50 Ft.	Hose Inner Diameter: 1/2" (12.7mm)	Hose Outer Diameter: 3/4" (19.4mm)	1001639552
Hose Size: No. 10			
Length: 50 Ft.	Hose Inner Diameter: 5/8" (15.9mm)	Hose Outer Diameter: 15/16" (23.6mm)	1001639553
Hose Size: No. 12			
Length: 825 Ft.	Hose Inner Diameter: 5/16" (7.9mm)	Hose Outer Diameter: 9/16" (14.7mm)	1001260067
Hose Size: No. 6			
Length: 600 Ft.	Hose Inner Diameter: 1/2" (12.7mm)	Hose Outer Diameter: 3/4" (19.4mm)	1002300971
Hose Size: No. 10			
Length: 600 Ft.	Hose Inner Diameter: 1/2" (12.7mm)	Hose Outer Diameter: 3/4" (19.4mm)	1001260075
Hose Size: No. 10			
Length: 425 Ft.	Hose Inner Diameter: 5/8" (15.9mm)	Hose Outer Diameter: 15/16" (23.6mm)	1002300976
Hose Size: No. 12			
Length: 425 Ft.	Hose Inner Diameter: 5/8" (15.9mm)	Hose Outer Diameter: 15/16" (23.6mm)	1001260076
Hose Size: No. 12			



Burgaflex Fittings

Burgaflex Fittings - Standard Barrier

FITTINGS

**Straight Fitting without Nut
(Standard Barrier)**



Fitting Size: No. 6	Hose Size: No. 6	1001457683
Fitting Size: No. 8	Hose Size: No. 8	1001457686
Fitting Size: No. 10	Hose Size: No. 10	1001457688

**Straight Fitting without Nut
(Standard Barrier, Step Up)**



Fitting Size: No. 6	Hose Size: No. 8	1001561385
---------------------	------------------	-------------------

**45 Degree Fitting without Nut
(Standard Barrier)**



Fitting Size: No. 10	Hose Size: No. 10	1001457850
Fitting Size: No. 12	Hose Size: No. 12	1001457852

**45 Degree Fiting without Nut
(Standard Barrier, Step Down)**



Fitting Size: No. 12	Hose Size: No. 10	1001457851
----------------------	-------------------	-------------------

**90 Degree Fitting without Nut
(Standard Barrier)**



Fitting Size: No. 6	Hose Size: No. 6	1001457853
Fitting Size: No. 8	Hose Size: No. 8	1001457854
Fitting Size: No. 10	Hose Size: No. 10	1001457855
Fitting Size: No. 12	Hose Size: No. 12	1001457857

**90 Degree Fitting without Nut
(Standard Barrier, Step Down)**



Fitting Size: No. 12	Hose Size: No. 10	1001457856
----------------------	-------------------	-------------------

Burgaflex Fittings - Reduced Barrier

**Straight Fitting without Nut
(Reduced Barrier)**



Fitting Size: No. 6	Hose Size: No. 6	1001457859
Fitting Size: No. 8	Hose Size: No. 8	1001457860
Fitting Size: No. 10	Hose Size: No. 10	1001457861
Fitting Size: No. 12	Hose Size: No. 12	1001457863

**Straight Fitting without Nut
(Reduced Barrier, Step Up)**



Fitting Size: No. 6	Hose Size: No. 8	1001561396
---------------------	------------------	-------------------

**45 Degree Fitting without Nut
(Reduced Barrier)**



Fitting Size: No. 6	Hose Size: No. 6	1001457868
Fitting Size: No. 8	Hose Size: No. 8	1001457869
Fitting Size: No. 10	Hose Size: No. 10	1001458217
Fitting Size: No. 12	Hose Size: No. 12	1001458220

**90 Degree Fitting without Nut
(Reduced Barrier)**



Fitting Size: No. 6	Hose Size: No. 6	1001458226
Fitting Size: No. 8	Hose Size: No. 8	1001458233
Fitting Size: No. 10	Hose Size: No. 10	1001458249
Fitting Size: No. 12	Hose Size: No. 12	1001458251

**90 Degree Fitting without Nut
(Reduced Barrier, Step Down)**



Fitting Size: No. 12	Hose Size: No. 10	1001458250
----------------------	-------------------	-------------------



Burgaflex Fittings

Burgaflex Crimp Fittings - Reduced Barrier

FITTINGS

**Straight Fitting without Nut
(Reduced Barrier)**



Fitting Size: No. 6	Hose Size: No. 6	1001458255
Fitting Size: No. 8	Hose Size: No. 8	1001458257
Fitting Size: No. 10	Hose Size: No. 10	1001458258
Fitting Size: No. 12	Hose Size: No. 12	1001458260

**Straight Fitting without Nut
(Reduced Barrier, Step Down)**



Fitting Size: No. 12	Hose Size: No. 10	1001458259
----------------------	-------------------	-------------------

**45 Degree Fitting without Nut
(Reduced Barrier)**



Fitting Size: No. 6	Hose Size: No. 6	1001458283
Fitting Size: No. 8	Hose Size: No. 8	1001458288
Fitting Size: No. 10	Hose Size: No. 10	1001458290
Fitting Size: No. 12	Hose Size: No. 12	1001458293

**45 Degree Fitting without Nut
(Reduced Barrier, Step Down)**



Fitting Size: No. 12	Hose Size: No. 10	1001458292
----------------------	-------------------	-------------------

**90 Degree Fitting without Nut
(Reduced Barrier)**



Fitting Size: No. 6	Hose Size: No. 6	1001458294
Fitting Size: No. 8	Hose Size: No. 8	1001458299
Fitting Size: No. 10	Hose Size: No. 10	1001458301
Fitting Size: No. 12	Hose Size: No. 12	1001458305

**90 Degree Fitting without Nut
(Reduced Barrier, Step Down)**



Fitting Size: No. 12	Hose Size: No. 10	1001458303
----------------------	-------------------	-------------------

Burgaflex Accessories

Hose Clip (package quantity of 10)



Hose Size: No. 6	1001458308
Hose Size: No. 8	1001458310
Hose Size: No. 10	1001458311
Hose Size: NO. 12	1001458313

Hose Clip Retainer



Hose Size: No. 6	1001458314
Hose Size: No. 10	1001458323
Hose Size: No. 12	1001458324

Part No: 1001458325



General Specifications: Hose Clamp Crimp Tool

Ferrule Fittings

Ferrule Fittings
(package quantity of 5)



Fitting Size: No. 6	530635
Fitting Size: No. 10	530637
Fitting Size: No. 12	530638



O-Rings

FITTINGS



580565



1002487273



570120



580123



1002487275



580113



564700



580124



572770



580125



580114



580210



589640



580089



1000233458



580092



580091

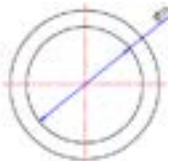

1002508371

NOTE: All O-Rings are shown actual size and packaged in quantities of 25



Slim line seal used in Freightliner applications
(Packaged in quantities of 10)

Part No	Description	OEM No.
1000039205	Slim Line No. 6	ABP N83 312076
1000039326	Slim Line No. 8	ABP N83 312060
1000039333	Slim Line No. 10	ABP N83 312092



Mini Stat seals used in Freightliner applications
(Packaged in quantities of 10)

Part No	Description	OEM No.	Color
1000039445	Mini Stat No. 6	ABP N83 312366	Red
1000039471	Mini Stat No. 8	ABP N83 312368	Red
1000039483	Mini Stat No. 10	ABP N83 312361	Red
1000039492	Mini Stat No. 12	ABP N83 312372	Red
1002508370	1 in. Stat Seal		

O-Rings Specifications*

Description/Applications	Part No	Material
No. 6 Hose Filter Dryer O-Ring, Ford No. 6 Springlock & Tube Fitting O-Ring, Ford Combination Valve Schrader Port O-Ring, GM VIR Pickup Tube O-Ring, Nissan No. 10 Hose Fitting & Filter Dryer O-Ring, Nissan 10mm Filter Dryer, Condenser O-Ring, Ford Expansion Valve O-Ring, GM DA6 Discharge Crossover O-Ring, Mazda No. 6 Springlock Fitting O-Ring, Diesel Kiki BH DKS13G Oil Plug O-Ring, Min. Pressure Relief Valve O-Ring, Volvo No. 6 Hose Fitting O-Ring, Hyundai No. 6 Springlock O-Ring	570120	Green HNBR
	580123	Black Neoprene
	1002487275	Yellow HNBR
No. 6 Compression Fitting O-Ring, Chrysler 6C17 Large Control Valve (Inner) O-Ring, York & Sanden Oil Plug O-Ring, GM Pressure Relief Valve O-Ring, Toyota Pressure Switch O-Ring, GM V5 Control Valve O-Ring, GM R-134a Two Piece 16mm Primary Seal O-Ring, Chrysler 6C17 Oil Plug & Pressure Relief Valve O-Ring, GM, Ford Pressure Cycling Switch O-Ring, Sanden Compressor 1/4" Service Port O-Ring, Mitsubishi FX105V Compressor Control Valve (Inner) O-Ring, GM In-Line Filter O-Ring, Volvo Cycling/Pressure Switch O-Ring	580113	Black Neoprene
	564700	Green HNBR
No. 8 Hose Fitting O-Ring, Ford No. 8 Tube Fitting & Non-metric Springlock O-Ring, Volvo No. 8 Hose Fitting O-Ring, Mazda No. 8 Springlock Fitting O-Ring, GM V5 Control Valve O-Ring, Nissan No. 12 Hose Fitting & Condenser Discharge Line O-Ring, Nissan 12mm STV Valve, Filter Dryer, Condenser, Hose Fitting O-Ring, GM VIR Inlet Fitting O-Ring, Toyota Discharge Line O-Ring, Aeroquip Two Piece 13mm R-134a Adapter O-Ring, Mazda O-Ring, Hyundai No. 8 Springlock O-Ring, Mitsubishi Hose Fitting O-Ring	580124	Black Neoprene
	572770	Green HNBR
No. 10 Hose Fitting O-Ring, Ford No. 10 Tube Fitting & Non-metric Springlock O-Ring, Nissan Evaporator Suction Fitting O-Ring, Nissan 16mm STV Valve, Evaporator, Hose Fitting O-Ring, Toyota Suction Line O-Ring, Volvo No. 10 Hose Fitting O-Ring, Mitsubishi Hose Fitting O-Ring, Nippondenso TV Manifold Port O-Ring, Nippondenso TV10/TV12C/TV14C Sensor Housing O-Ring, Mazda Hose Fitting O-Ring, York, Tecumseh Tube-O Valve O-Ring, Aeroquip Two Piece 16mm Adapter O-Ring	580125	Black Neoprene
	580114	Green HNBR
No. 12 Hose Fitting O-Ring, Ford No. 12 Tube Fitting & Non-metric Springlock O-Ring, VIR Expansion Valve Lower O-Ring, VIR Evaporator Fitting Outlet O-Ring, VIR Connection to Evaporator Suction Line O-Ring, GM V5 Control Valve O-Ring, Chrysler 6C17 Small Control Valve O-Ring, Volvo No. 12 Hose Fitting O-Ring, Nissan 19mm Evaporator Suction O-Ring	580210	Black Neoprene
	580089	Black Neoprene
No. 8 GM Captive O-Ring, Chrysler 6C17 Large Control Outer O-Ring	580092	Black Neoprene
No. 10 GM Captive O-Ring, GM DA6, Sanden SD505/507/TR70/TR90 Compressor Shaft Seal Head O-Ring, Hitachi Compressor Crossover O-Ring, Matsushita Compressor Model S1150 Carbon Seal Head O-Ring	580091	Black Neoprene
No. 12 GM Captive O-Ring, GM A6, R4, Sanden SD708/709 Compressor Shaft Seal Head O-Ring, Mitsubishi Compressor Model FX80 Suction Port O-Ring, Nihon Compressor Model DKV14C Carbon Seal O-Ring	1000233458	Black EPDM
5/8" O-Ring, Water, Antifreeze	580565	Green HNBR
O-Ring	1002487273	Yellow HNBR
O-Ring, Water Valve Fitting	589640	HQ Nitrile
1 in HNBR O-Ring	1002508371	HNBR
1.84 in HNBR O-Ring	1000259338	HNBR

* All o-rings purchased separately are packaged in quantities of 25.



O-Rings

O-Ring Assortment Kits

FITTINGS

Description	Part No
O-Ring & Service Assortment Kit	550367



NOTE: Complete kit may be ordered by Part Number 2799201. Individual parts may be ordered by referencing the part number for each item as listed in the table (to right).

Kit Contents:

Part No	Qty.	Description
	7	GM Compressor Port O-Ring, Black Neoprene
580089	7	No. 8 GM Captured O-Ring, Black Neoprene
580125	7	No. 10 Hose Fitting O-Ring, Black Neoprene
	7	Equalizer Tube O-Ring, Black Neoprene
580124	7	No. 8 Hose Fitting O-Ring, Black Neoprene
580091	7	No. 12 Captured Fitting O-Ring, Black Neoprene
	7	No. 6 Captured O-Ring, Black Neoprene
580210	7	No. 12 Hose Fitting O-Ring, Black Neoprene
570120	7	No. 6 Hose Fitting O-Ring, Green HNBR
	10	CCI & Tecumseh Rotolock Service Valve Teflon Seal
	3	CCI & Tecumseh Long Stem Cap
580108	10	Charging Port Cap (3/16")
	10	Service Valve Cap (1/4")
	1	A-6 Shaft Nut
	1	Washer
	10	Charging Hose Seal
580099	10	Charging Hose Depressor
	10	Can Tap Seal Gasket
	3	CCI & Tecumseh Compressor Woodruff Key
	3	Sanden Shaft Key
550403	20	Schrader Valve Core

Description	Part No
Job O-Ring Assortment Kit	525674



Kit Contents:

Qty.	Description
1	O-Ring No. 4
7	O-Ring No. 6
6	O-Ring No. 8
4	O-Ring No. 10
1	O-Ring No. 12

Description	Part No
Metric O-Ring Kit	869437





Kit Contents:

Part No	Description
	Compressor Switch Port Oil Plug O-Ring, Black Neoprene
564700	No. 8 Hose Fitting O-Ring, Green HNBR
572770	No. 10 Hose Fitting O-Ring, Green HNBR
	No. 5 (7MM) Toyota Fitting Seal
	Nissan No. 8 Hose Fitting/Drier O-Ring
570120	Nissan No. 10 Hose Fitting/Drier O-Ring, Green HNBR
580125	Nissan Evaporator Suction Line O-Ring, Green HNBR
580565	Nissan Condenser Liquid Line O-Ring
580124	Nissan Compressor Flange O-Ring, Green HNBR

Qty. 10 each per complete kit.

O-Ring Assortment Kits (cont'd)

Description	Part No	Kit Contents:																		
Freightliner Stat Seal & Sealing Washer Assortment Kit	1002430992	<table border="1"> <thead> <tr> <th>Part No</th> <th>Description</th> </tr> </thead> <tr> <td>1000039205</td> <td>No. 6 Slim Line Washer, Black</td> </tr> <tr> <td>1000039326</td> <td>No. 8 Slim Line Washer, Black</td> </tr> <tr> <td>1000039333</td> <td>No. 10 Slim Line Washer, Black</td> </tr> <tr> <td>1000039445</td> <td>No. 6 Mini Stat Seal Washer, Red</td> </tr> <tr> <td>1000039471</td> <td>No. 8 Mini Stat Seal Washer, Red</td> </tr> <tr> <td>1000039483</td> <td>No. 10 Mini Stat Seal Washer, Red</td> </tr> <tr> <td>1000039492</td> <td>Comp. Suction/Discharge Mini Stat Seal, Red</td> </tr> <tr> <td>1002508370</td> <td>No. 12 Mini Stat Seal Washer, Red</td> </tr> </table>	Part No	Description	1000039205	No. 6 Slim Line Washer, Black	1000039326	No. 8 Slim Line Washer, Black	1000039333	No. 10 Slim Line Washer, Black	1000039445	No. 6 Mini Stat Seal Washer, Red	1000039471	No. 8 Mini Stat Seal Washer, Red	1000039483	No. 10 Mini Stat Seal Washer, Red	1000039492	Comp. Suction/Discharge Mini Stat Seal, Red	1002508370	No. 12 Mini Stat Seal Washer, Red
Part No	Description																			
1000039205	No. 6 Slim Line Washer, Black																			
1000039326	No. 8 Slim Line Washer, Black																			
1000039333	No. 10 Slim Line Washer, Black																			
1000039445	No. 6 Mini Stat Seal Washer, Red																			
1000039471	No. 8 Mini Stat Seal Washer, Red																			
1000039483	No. 10 Mini Stat Seal Washer, Red																			
1000039492	Comp. Suction/Discharge Mini Stat Seal, Red																			
1002508370	No. 12 Mini Stat Seal Washer, Red																			
		<p>Qty. 10 each per complete kit.</p>																		

Description	Part No	Kit Contents:																																																		
Master Deluxe O-Ring & Sealing Assortment Kit	1002431343	<table border="1"> <thead> <tr> <th>Part No</th> <th>Description</th> </tr> </thead> <tr> <td>570120</td> <td>No. 6 GM/Ford, Chrysler/Import Hose Fitting O-Ring, Green HNBR</td> </tr> <tr> <td>564700</td> <td>No. 8 Ford Springlock Fitting O-Ring, Green HNBR</td> </tr> <tr> <td>572770</td> <td>No. 10 Ford Springlock Fitting O-Ring, Green HNBR</td> </tr> <tr> <td>580114</td> <td>No. 12 Ford Springlock Fitting O-Ring, Green HNBR</td> </tr> <tr> <td>1002487273</td> <td>Nissan Condenser Liquid Line O-Ring, Yellow HNBR</td> </tr> <tr> <td>1002487275</td> <td>No. 6 Hose Fitting O-Ring, Yellow HNBR</td> </tr> <tr> <td>550403</td> <td>Standard Flow Valve Core</td> </tr> <tr> <td>551354</td> <td>High Flow Valve Core</td> </tr> <tr> <td>550397</td> <td>High Flow Valve Core</td> </tr> <tr> <td>550398</td> <td>High Flow Valve Core</td> </tr> <tr> <td>1000417503</td> <td>1/2 C-Plate Seal</td> </tr> <tr> <td>1000417507</td> <td>3/4 C-Plate Seal</td> </tr> <tr> <td></td> <td>High Flow M8 Valve Core</td> </tr> <tr> <td>1000039445</td> <td>Freightliner Drier/TXV No. 6 Stat Seal Washer</td> </tr> <tr> <td>1000039471</td> <td>Freightliner Drier/TXV No. 8 Stat Seal Washer</td> </tr> <tr> <td>1000039492</td> <td>Freightliner Compressor Suction/Discharge Stat Seal</td> </tr> <tr> <td>1000039483</td> <td>Freightliner Drier/TXV No. 10 Stat Seal Washer</td> </tr> <tr> <td>1002508370</td> <td>Freightliner No. 12 Suction Stat Seal</td> </tr> <tr> <td>550253</td> <td>R134a Low Side Cap, Blue</td> </tr> <tr> <td></td> <td>R134a 13mm High Side Standard Flow Cap, Red</td> </tr> <tr> <td>B360874</td> <td>13mm High Flow Cap, Blue</td> </tr> <tr> <td>551112</td> <td>AC Discharge Cap, Red</td> </tr> <tr> <td>550399</td> <td>AC Charge Cap, Red</td> </tr> <tr> <td>550401</td> <td>16mm Eaton Port Cap</td> </tr> </table>	Part No	Description	570120	No. 6 GM/Ford, Chrysler/Import Hose Fitting O-Ring, Green HNBR	564700	No. 8 Ford Springlock Fitting O-Ring, Green HNBR	572770	No. 10 Ford Springlock Fitting O-Ring, Green HNBR	580114	No. 12 Ford Springlock Fitting O-Ring, Green HNBR	1002487273	Nissan Condenser Liquid Line O-Ring, Yellow HNBR	1002487275	No. 6 Hose Fitting O-Ring, Yellow HNBR	550403	Standard Flow Valve Core	551354	High Flow Valve Core	550397	High Flow Valve Core	550398	High Flow Valve Core	1000417503	1/2 C-Plate Seal	1000417507	3/4 C-Plate Seal		High Flow M8 Valve Core	1000039445	Freightliner Drier/TXV No. 6 Stat Seal Washer	1000039471	Freightliner Drier/TXV No. 8 Stat Seal Washer	1000039492	Freightliner Compressor Suction/Discharge Stat Seal	1000039483	Freightliner Drier/TXV No. 10 Stat Seal Washer	1002508370	Freightliner No. 12 Suction Stat Seal	550253	R134a Low Side Cap, Blue		R134a 13mm High Side Standard Flow Cap, Red	B360874	13mm High Flow Cap, Blue	551112	AC Discharge Cap, Red	550399	AC Charge Cap, Red	550401	16mm Eaton Port Cap
Part No	Description																																																			
570120	No. 6 GM/Ford, Chrysler/Import Hose Fitting O-Ring, Green HNBR																																																			
564700	No. 8 Ford Springlock Fitting O-Ring, Green HNBR																																																			
572770	No. 10 Ford Springlock Fitting O-Ring, Green HNBR																																																			
580114	No. 12 Ford Springlock Fitting O-Ring, Green HNBR																																																			
1002487273	Nissan Condenser Liquid Line O-Ring, Yellow HNBR																																																			
1002487275	No. 6 Hose Fitting O-Ring, Yellow HNBR																																																			
550403	Standard Flow Valve Core																																																			
551354	High Flow Valve Core																																																			
550397	High Flow Valve Core																																																			
550398	High Flow Valve Core																																																			
1000417503	1/2 C-Plate Seal																																																			
1000417507	3/4 C-Plate Seal																																																			
	High Flow M8 Valve Core																																																			
1000039445	Freightliner Drier/TXV No. 6 Stat Seal Washer																																																			
1000039471	Freightliner Drier/TXV No. 8 Stat Seal Washer																																																			
1000039492	Freightliner Compressor Suction/Discharge Stat Seal																																																			
1000039483	Freightliner Drier/TXV No. 10 Stat Seal Washer																																																			
1002508370	Freightliner No. 12 Suction Stat Seal																																																			
550253	R134a Low Side Cap, Blue																																																			
	R134a 13mm High Side Standard Flow Cap, Red																																																			
B360874	13mm High Flow Cap, Blue																																																			
551112	AC Discharge Cap, Red																																																			
550399	AC Charge Cap, Red																																																			
550401	16mm Eaton Port Cap																																																			
		<p>Qty. 2 each per complete kit.</p>																																																		

FITTINGS



O-Ring Kit Listing

Kit Description	Contents	Part No
Metric O-Ring Kit	A complete assortment of green R-134a O-Rings. (shown on previous page)	869437
Deluxe O-Ring Kit	A complete assortment of O-Rings along with seals, gaskets, Schrader valves, expansion valve screens and caps for R-12 and R-134a. (shown on previous page)	550367
Job O-Ring Assortment Kit	Various size o-rings (shown on previous page)	525674

Bulkhead Adapters, Tubing & Drain Hoses

O-Ring Assortment Kits (cont'd)

O-Ring Kit Listing

Kit Description	Contents	Part No
Freightliner Stat Seal & Sealing Washer Assortment Kit	An assortment of slimline washers and stat seals	1002430992
Master Deluxe O-Ring & Sealing Washer Assortment Kit	A complete assortment of O-Rings, valve cores, c-plates, stat seals and washers	1002431343

O-Ring Rubber Material Data

Rubber Type / Designation	Color	Automotive Application
Nitrile Buna / Buna N / NBR (Nitrile Butadiene Rubber)	Black	<ul style="list-style-type: none"> AC Systems with R-12 Refrigerant & Mineral Oil Power Steering / Rack & Pinion Systems Heater Systems Fuel Systems
HSN (Highly Saturated Nitrile) / HNBR (Hydrogenated Nitrile Butadiene Rubber)	Green or Yellow	<ul style="list-style-type: none"> AC Systems with R-12 Refrigerant & Mineral Oil AC Systems with R-134a Refrigerant & PAG (Polyalkylene Glycol) or POE (Polyol Ester) Refrigerant Oils
Neoprene / CR (Chloroprene Rubber)	Black, Red or Blue Tinted	<ul style="list-style-type: none"> Same as above



Bulkhead Adapters

Coupling and Nut Jam Kit



Hose Size: No. 8	Fitting Thread Size: 3/4"-16	Tube Size: 1/2"	1002106852
Hose Size: No. 12	Fitting Thread Size: 1 1/16"-14	Tube Size: 3/4"	1002106854

Coupling Only

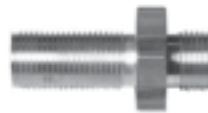

Hose Size: No. 6	Fitting Thread Size: 5/8"-18	Tube Size: 3/8"	B405430
Hose Size: No. 8	Fitting Thread Size: 3/4"-16	Tube Size: 1/2"	B405431
Hose Size: No. 10	Fitting Thread Size: 7/8"-14	Tube Size: 5/8"	B405434
Hose Size: No. 12	Fitting Thread Size: 1 1/16"-14	Tube Size: 3/4"	B405433

Nut Jam Only

(packaged in quantities of 10)



Hose Size: No. 6	Fitting Thread Size: 5/8"-18	Tube Size: 3/8"	B203845
Hose Size: No. 10	Fitting Thread Size: 7/8"-14	Tube Size: 5/8"	B203846

Drain Hose & Accessories

Part No: 560101



General Specifications: Drain Tube

Part No: 585790



General Specifications: 9/16" (14.3mm) diameter rubber drain valve

Part No: 100004640



General Specifications: Drain Tube

Part No: 1000988616



General Specifications: Drain Hose Kit

Part No: 1000988618



General Specifications: Drain Hose Kit

Part No: B300014



General Specifications: 1/2" Inner Diameter Drain Hose (order in 12 feet increments)

Part No: B173070



General Specifications: 1/2" Inner Diameter Check Valve Drain Tube

Part No: B300515



General Specifications: 1/2" Inside Diameter Drain Hose (order in bulk)

Part No: B360208



General Specifications: 1/2" Inner Diameter T-Fitting Drain Hose

Part No: B360312



General Specifications: Plastic 1/2" x 1/2" 90 deg Elbow Fitting



Bulkhead Adapters, Tubing & Drain Hoses

Insulation Tubing

Part No: 651462



General Specifications: Heat Shrink Tubing

FITTINGS

Tube & Fitting Assembly

Quick Disconnect Coupler



Fitting Size: 5/8"-18

550182

Fitting



Fitting Size: No. 6

Fitting Thread Size: 5/8"-18

Tube Size: 3/8"

550215

Fitting Size: No. 8

Fitting Thread Size: 5/8"-18 to 1 1/16"-14

Tube Size: 5/8"

550216

Heater Tube Fitting



Fitting Thread Size: 7/8"-14

Tube Size: 5/8"

550051

Fitting



Fitting Thread Size: 7/8"-14 to 1 1/16"-14

Tube Size: 5/8"

550159

Tube & Fitting Assembly



Fitting Thread Size: 5/8"-18

Tube Size: 3/8"

B405576

Part No: 1001420921



Fitting Thread Size: No. 6, 3/8" O-Ring Short Pilot Tube with 3/8" Male Swivel Nut & No. 8, 1/2" O-Ring Long Pilot Tube with 1/2" Female Swivel Nut

Fitting Thread Size: 5/8-18 Thread & 3/4-16 Thread

Flexible Ducting

Bulk Flexible Ducting



Fitting Size: 2" (50.8mm)	Hose Inner Diameter: 2" (50.8mm)	Length: 50 Ft.	B311000
Fitting Size: 2 1/2" (63.5mm)	Hose Inner Diameter: 2 1/2" (63.5mm)	Length: 50 Ft.	B312000
Fitting Size: 3" (76.2mm)	Hose Inner Diameter: 3" (76.2mm)	Length: 50 Ft.	B314000
Fitting Size: 3 1/2"	Hose Inner Diameter: 3 1/2" (88.9mm)	Length: 50 Ft.	B315000
Fitting Size: 4" (101.6mm)	Hose Inner Diameter: 4" (101.6mm)	Length: 50 Ft.	B316000

FITTINGS



Hose Clamps

Part No: B290065
(packaged in quantities of 10)



General Specifications: Double hose clamp
Clamp Inner Diameter: 2" max.

Part No: 1003389790
(packaged in quantities of 10)



General Specifications: Cable clamp
Clamp Inner Diameter: 3/16" max.

Hose/Duct Clamp
(packaged in quantities of 25)



Fitting Size: .56" (14.22mm)	Clamp Inner Diameter: 1/2" min. to 1" max.	B290214
	Clamp Inner Diameter: 5/8" min. to 1 1/4" max.	B290304
Fitting Size: 3.12" (79.25mm)	Clamp Inner Diameter: 3" min. to 4 1/4" max.	B290303

Accessories

Hoses

FITTINGS

Part No: B320000



Hose Inner Diameter: 5/8"

Hose Outer Diameter: 15/16"

Length: 50 Ft. Rolls

General Specifications: Heater Hose

Part No: 1002080211



Hose Inner Diameter: 5/16"

Hose Outer Diameter: 19/32"

Length: 50 Ft. Rolls

General Specifications: #6 Eaton GH001 Hose

Part No: 560126



General Specifications: 1" 90 Degree Formed Heater Hose

Part No: 560127



General Specifications: 1" 180 Degree Formed Heater Hose

Part No: 560235



General Specifications: 4 x 45 in Defrost Hose

Wire Clips & Ties

Part No: B360113



General Specifications: 8" Long Heavy-duty Plastic Ties

Part No: B360849



General Specifications: Push Mount Tie Wrap

Package Size: 50 Ft